

SKF 7021 CD/HCP4AH1参数

主要尺寸	d	105	mm	-
	D	160	mm	-
	B	26	mm	-
基本额定载荷	C	95600	N	动载荷
	C_0	96500	N	静载荷
疲劳载荷极限	P_u	3600	N	-
可达转速	Grease	10000	r/min	-
	Oil-air	15000	r/min	-
重量	重量	1300	g	-
型号	型号	7021 CD/HCP4AH1	-	-

SKF 7021 CD/HCP4AH1图片

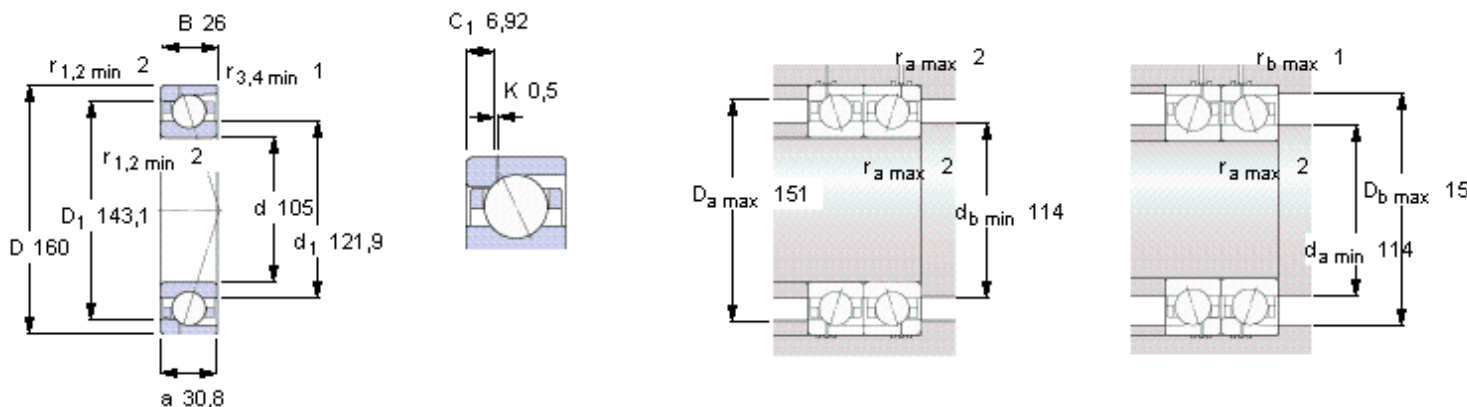

Ball diameter 17,462

Number of balls 21

未安装时的预载荷 [N]

背对背配置，面对面配置

预载荷等级

A	B	C	D
360	720	1440	2880

Static axial stiffness [N/ μm]

(guideline value)

预载荷等级

A	B	C	D
129	176	248	359

Reference grease quantity [cm³]

G_{ref} 20

计算系数

for equivalent bearing load

f_0 15,7

for preload in mounted bearing sets

f 1,15

f_1 1

f_{2A} 1

f_{2B} 1,02

f_{2C} 1,05

f_{2D} 1,09

f_{HC} 1,02

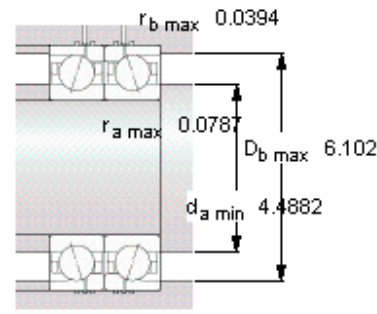
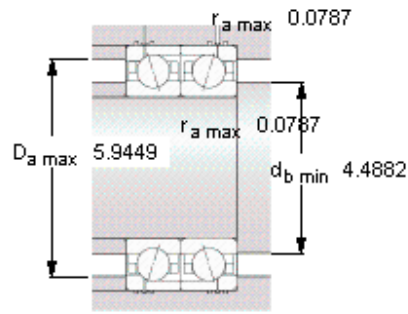
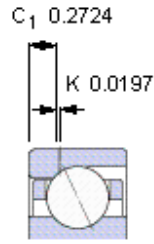
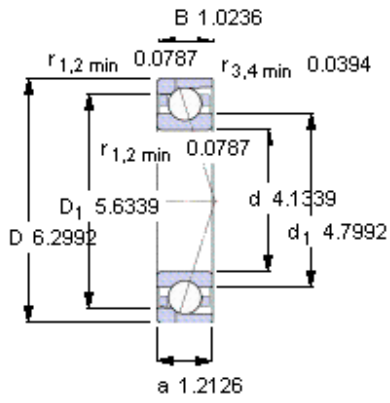

Ball diameter 17,462

Number of balls 21

未安装时的预载荷 [N]

背对背配置，面对面配置

预载荷等级

A	B	C	D
360	720	1440	2880

Static axial stiffness [N/μm]

(guideline value)

预载荷等级

A	B	C	D
129	176	248	359

Reference grease quantity [cm³]

G_{ref} 20

计算系数

for equivalent bearing load

f₀ 15,7

for preload in mounted bearing sets

f 1,15

f₁ 1

f_{2A} 1

f_{2B} 1,02

f_{2C} 1,05

f_{2D} 1,09

f_{HC} 1,02