

SKF 53203参数

主要尺寸	d	17	mm	-
	D	35	mm	-
	H ₁	15	mm	-
基本额定载荷	C	17200	N	动载荷
	C ₀	30000	N	静载荷
疲劳载荷极限	P _u	1100	N	-
最小载荷系数	A	0.005	-	-
额定转速	额定转度	6700	r/min	-
	极限转速	9500	r/min	-
重量	轴承+垫圈	71	g	-
型号	轴承	53203	-	-
	座圈	U 203	-	-

SKF 53203图片

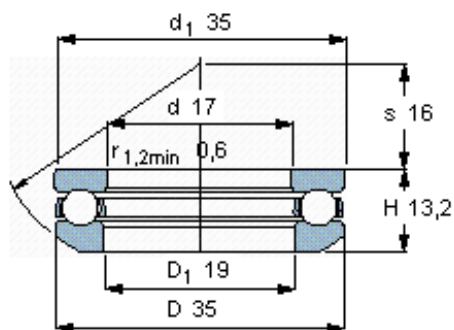

垫圈的球面曲率半径

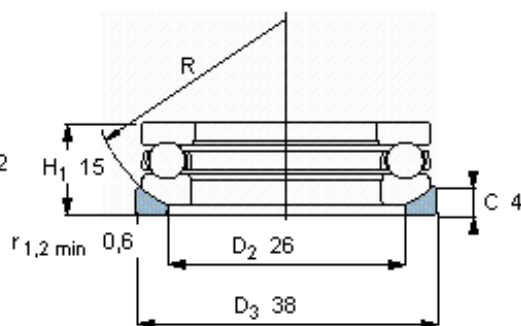

R 32

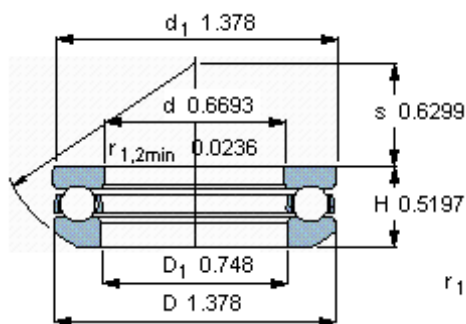
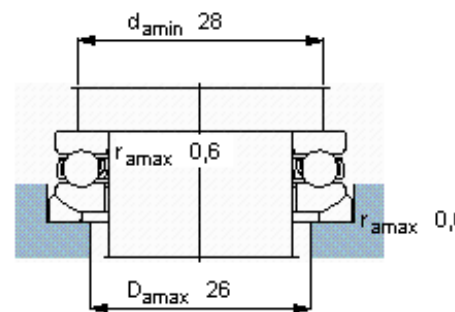

垫圈的球面曲率半径

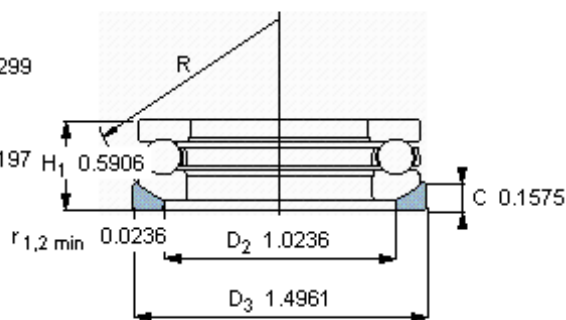

R 1.2598

