

SKF 89428 M参数

主要尺寸	d	140	mm	-
	D	280	mm	-
	H	85	mm	-
基本额定载荷	C	1100000	N	动载荷
	C_0	4800000	N	静载荷
疲劳载荷极限	P_u	425000	N	-
最小载荷系数	A	1.8	-	-
额定转速	额定转度	530	r/min	-
	极限转速	1100	r/min	-
重量	重量	27000	g	-
型号	完整轴承	89428 M	-	-
	滚子和保持架推力组件	K 89428 M	-	-

SKF 89428 M图片

完整轴承

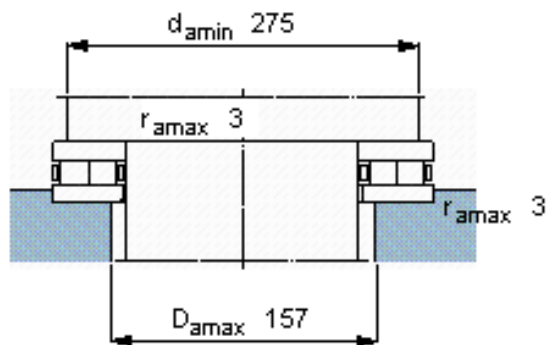
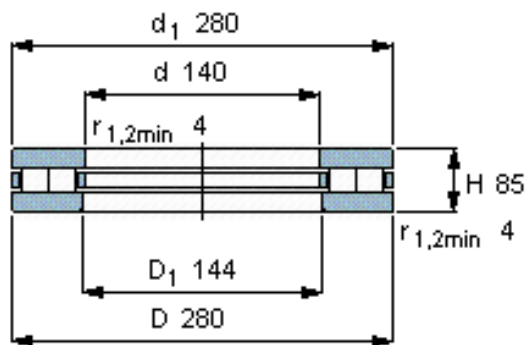

滚子和保持架推力组件

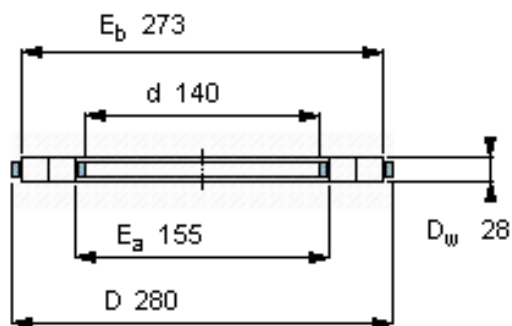

适宜的部件

轴垫圈
WS 89428

轴承座垫圈
GS 89428

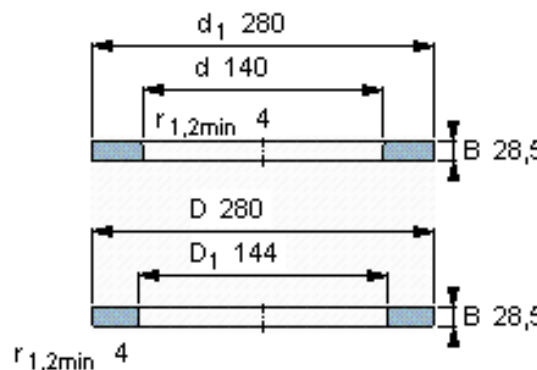

K 89428 M

质量 kg 6,40

完整轴承

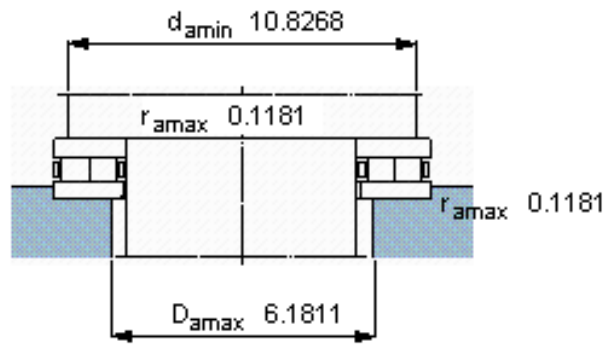
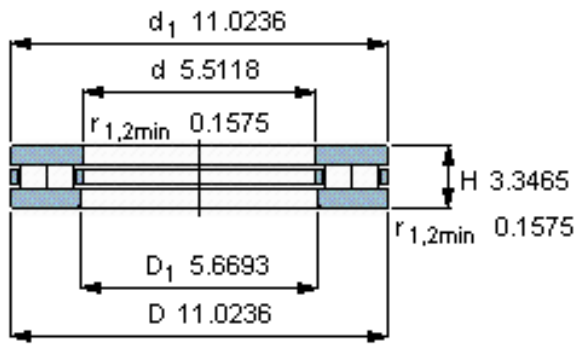

滚子和保持架推力组件

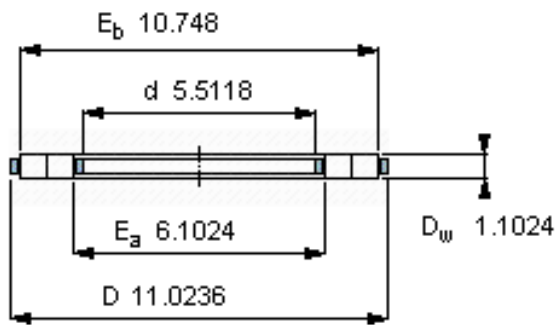

K 89428 M

质量 kg 6,40

适宜的部件

轴垫圈
WS 89428

轴承座垫圈
GS 89428

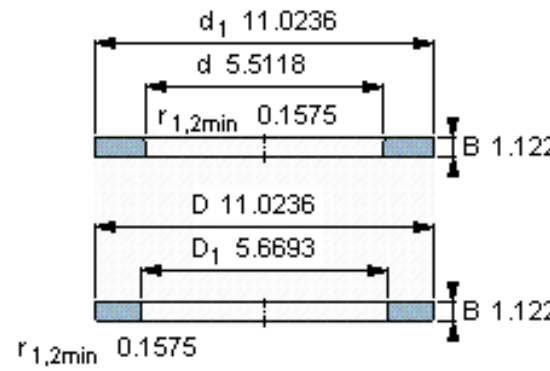

参考资料: <http://www.sozhou.com/p/c7b5b441.html>