

SKF 71964 ACDMA/HCP4A参数

主要尺寸	d	320	mm	-
	D	440	mm	-
	B	56	mm	-
基本额定载荷	C	351000	N	动载荷
	C_0	585000	N	静载荷
疲劳载荷极限	P_u	12900	N	-
可达转速	Grease	2600	r/min	-
	Oil-air	4000	r/min	-
重量	重量	20500	g	-
型号	型号	71964 ACDMA/HCP4A	-	-

SKF 71964 ACDMA/HCP4A图片

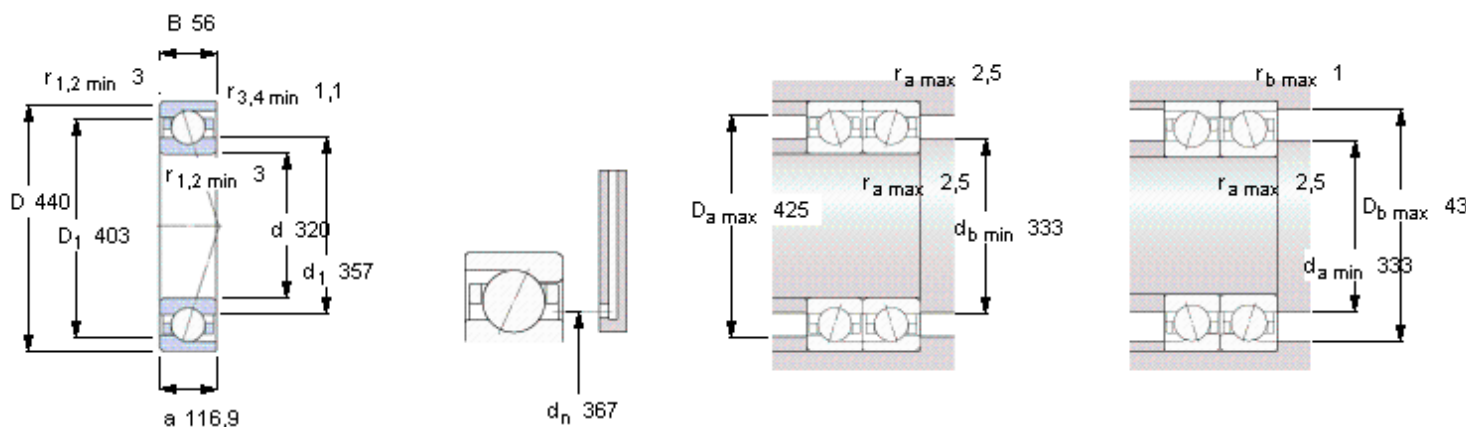

Ball diameter 38,1
Number of balls 27

未安装时的预载荷 [N]
背对背配置，面对面配置

预载荷等级			
A	B	C	D
2200	4400	8800	17600

Static axial stiffness [N/μm]
(guideline value)

预载荷等级			
A	B	C	D
758	991	1313	1774

Reference grease quantity [cm³]
 G_{ref} 282

计算系数

for equivalent bearing load

	单列，串联	背对背配置，面对面配置
e	0,68	0,68
X_1	1	1
Y_1	0	0,92
X_2	0,41	0,67
Y_2	0,87	1,41
X_0	0,5	1
Y_0	0,38	0,76

for preload in mounted bearing sets

f	1,24
f_1	0,98
f_{2A}	1
f_{2B}	1,07
f_{2C}	1,12
f_{2D}	1,17
f_{HC}	1,04

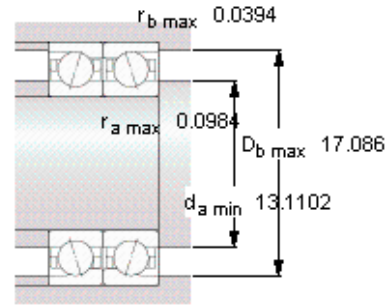
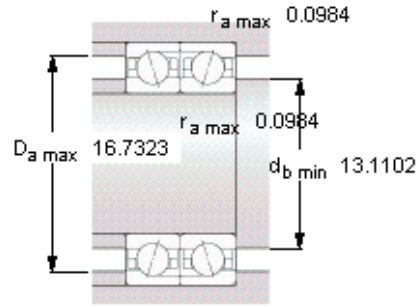
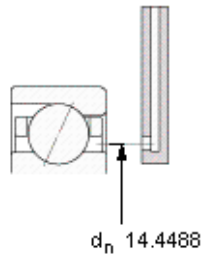
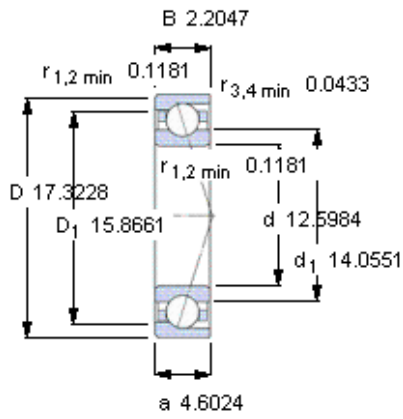

Ball diameter 38,1
Number of balls 27

未安装时的预载荷 [N]

背对背配置，面对面配置

预载荷等级

A	B	C	D
2200	4400	8800	17600

Static axial stiffness [N/μm]

(guideline value)

预载荷等级

A	B	C	D
758	991	1313	1774

Reference grease quantity [cm³]

G_{ref} 282

计算系数

for equivalent bearing load

	单列，串联	背对背配置，面对面配置
e	0,68	0,68
X ₁	1	1
Y ₁	0	0,92
X ₂	0,41	0,67
Y ₂	0,87	1,41
X ₀	0,5	1
Y ₀	0,38	0,76

for preload in mounted bearing sets

f	1,24
f ₁	0,98
f _{2A}	1
f _{2B}	1,07
f _{2C}	1,12
f _{2D}	1,17
f _{HC}	1,04