

TIMKEN 21314EJ参数

轴承型号	Part Number	21314EJ		-
尺寸	d	69.9999	mm	内径
	D	150	mm	外径
	B	35.0012	mm	宽度
额定载荷	C1	291803	N	一百万转动态径向载荷
	C0	289134	N	静态额定载荷
	$e = 1.5 * \tan$ (contact angle)	0.23		-
	$Y1 = 0.45 / \tan$ (contact angle)	2.97		系数
	$Y2 = 0.67 / \tan$ (contact angle)	4.42		系数
几何结构系数	Cg	0.0677		几何系数
极限转速	oil	4500		润滑油
	grease	3700		润滑脂
尺寸	da	92.71	mm	轴肩直径
	Da	134.62	mm	轴承座挡肩直径
重量	Assembly Weight	2921.13	g	-

TIMKEN 21314EJ图片

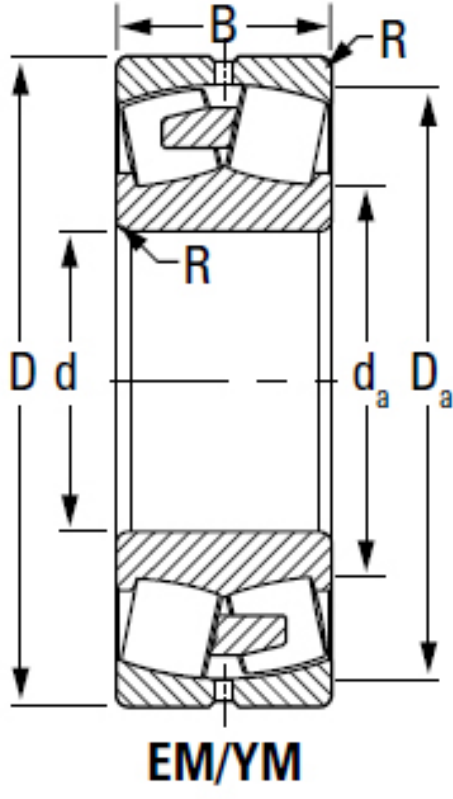



YM/EM

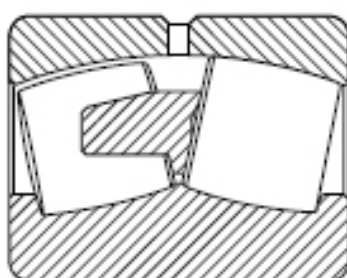

YMB/EMB



YMD

机加工保持架



EJ



EM/YM 和 EMB/YMB



YMD



YP

类型	保持架设计
EJ	内圈引导钢保持架：每列一个
EM/YM	滚子引导一片式黄铜保持架
EMB/YMB	内圈引导一片式黄铜保持架
YMD	内圈引导两片式黄铜保持架
YP	销式钢保持架