

SKF 53317参数

主要尺寸	d	85	mm	-
	D	150	mm	-
	H ₁	58	mm	-
基本额定载荷	C	190000	N	动载荷
	C ₀	465000	N	静载荷
疲劳载荷极限	P _u	16000	N	-
最小载荷系数	A	1.1	-	-
额定转速	额定转度	1600	r/min	-
	极限转速	2200	r/min	-
重量	轴承+垫圈	4350	g	-
型号	轴承	53317	-	-
	座圈	U 317	-	-

SKF 53317图片

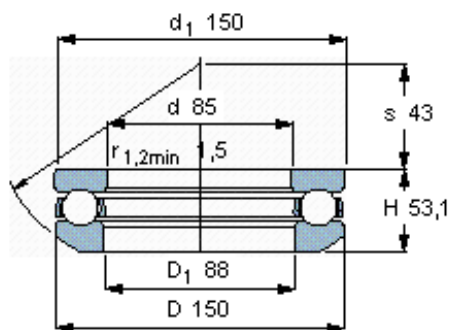

垫圈的球面曲率半径

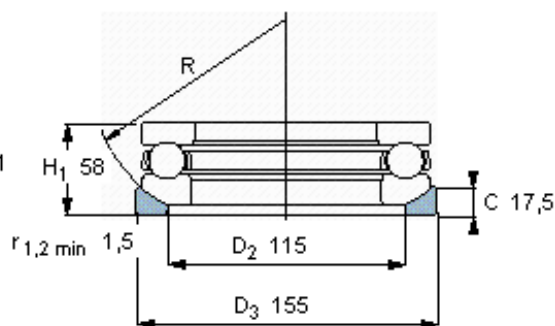

R 112

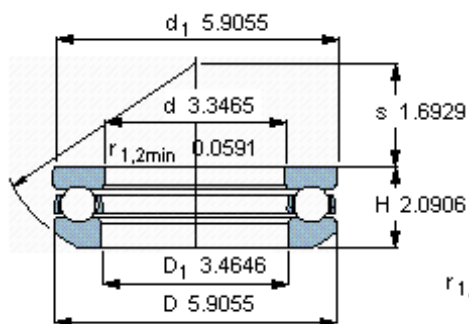
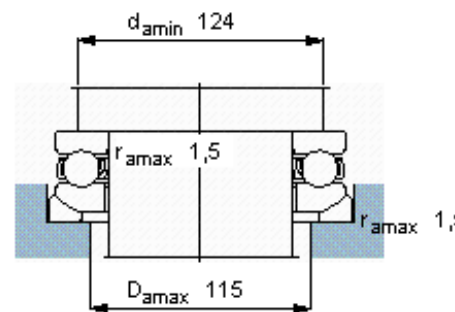

垫圈的球面曲率半径

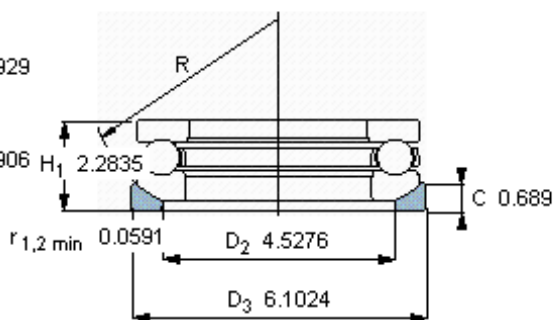

R 4.4094

