

SKF 71911 CD/P4AL参数

主要尺寸	d	55	mm	-
	D	80	mm	-
	B	13	mm	-
基本额定载荷	C	19500	N	动载荷
	C_0	14600	N	静载荷
疲劳载荷极限	P_u	620	N	-
可达转速	Grease	16000	r/min	-
	Oil-air	26000	r/min	-
重量	重量	180	g	-
型号	型号	71911 CD/P4AL	-	-

SKF 71911 CD/P4AL图片

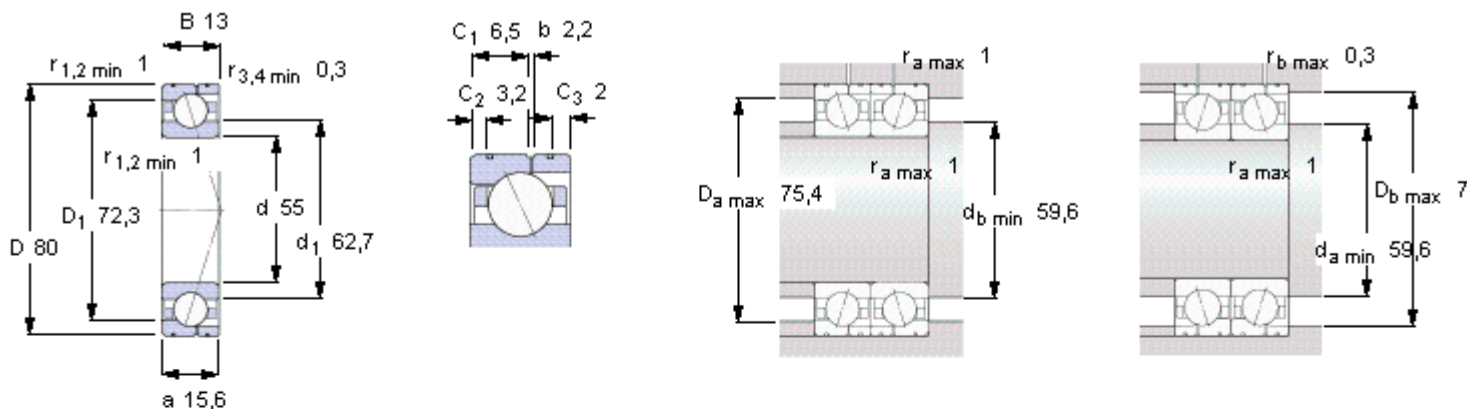

Ball diameter 7,938

Number of balls 23

未安装时的预载荷 [N]

背对背配置，面对面配置

预载荷等级

A	B	C	D
70	140	280	560

Static axial stiffness [N/μm]

(guideline value)

预载荷等级

A	B	C	D
49	65	89	126

Reference grease quantity [cm³]

G_{ref} 2,5

计算系数

for equivalent bearing load

f_0 10,4

for preload in mounted bearing sets

f 1,15

f_1 1

f_{2A} 1

f_{2B} 1,04

f_{2C} 1,09

f_{2D} 1,15

f_{HC} 1

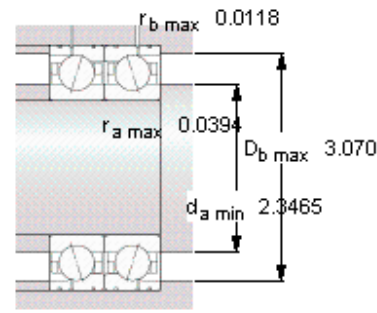
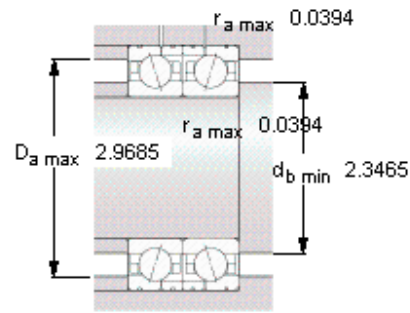
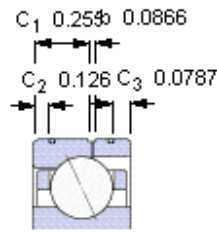
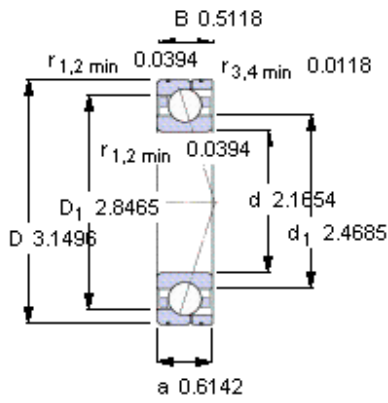

Ball diameter 7,938

Number of balls 23

未安装时的预载荷 [N]

背对背配置，面对面配置

预载荷等级

A	B	C	D
70	140	280	560

Static axial stiffness [N/μm]

(guideline value)

预载荷等级

A	B	C	D
49	65	89	126

Reference grease quantity [cm³]

G_{ref} 2,5

计算系数

for equivalent bearing load

f₀ 10,4

for preload in mounted bearing sets

f 1,15

f₁ 1

f_{2A} 1

f_{2B} 1,04

f_{2C} 1,09

f_{2D} 1,15

f_{HC} 1