

SKF 7026 CD/HCP4AH1参数

主要尺寸	d	130	mm	-
	D	200	mm	-
	B	33	mm	-
基本额定载荷	C	148000	N	动载荷
	C_0	156000	N	静载荷
疲劳载荷极限	P_u	5200	N	-
可达转速	Grease	8000	r/min	-
	Oil-air	13000	r/min	-
重量	重量	2650	g	-
型号	型号	7026 CD/HCP4AH1	-	-

SKF 7026 CD/HCP4AH1图片

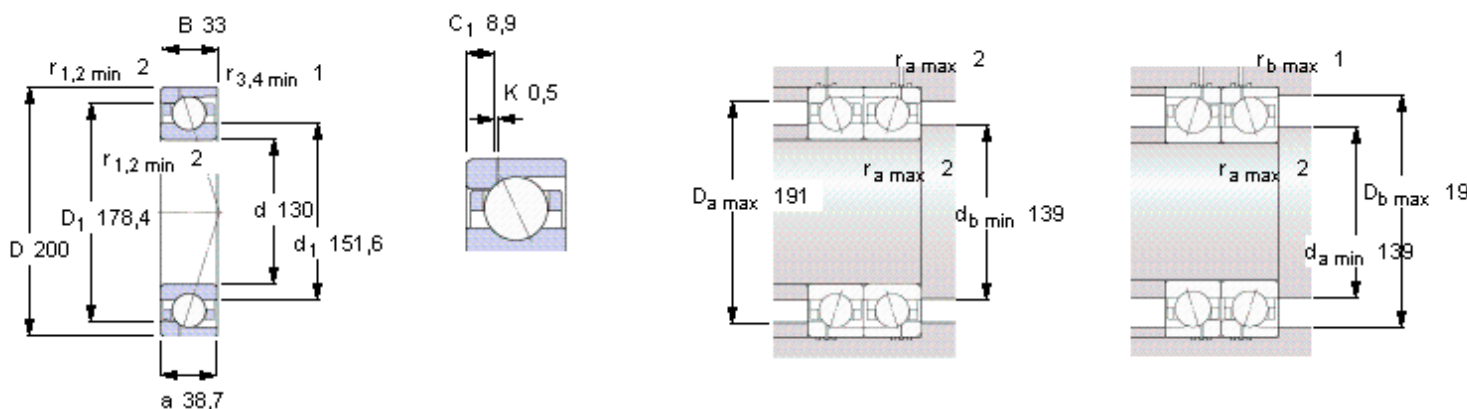

Ball diameter 22,225

Number of balls 21

未安装时的预载荷 [N]

背对背配置，面对面配置

预载荷等级

A	B	C	D
560	1120	2240	4480

Static axial stiffness [N/ μm]

(guideline value)

预载荷等级

A	B	C	D
161	219	307	444

Reference grease quantity [cm³]

G_{ref} 42

计算系数

for equivalent bearing load

f_0 15,6

for preload in mounted bearing sets

f 1,15

f_1 1

f_{2A} 1

f_{2B} 1,02

f_{2C} 1,05

f_{2D} 1,09

f_{HC} 1,02

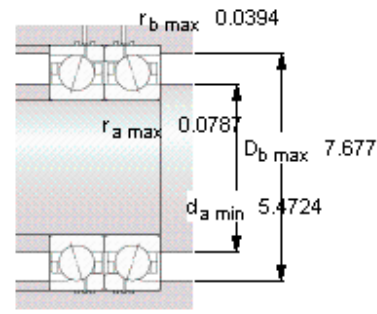
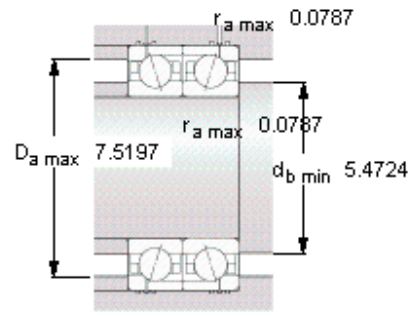
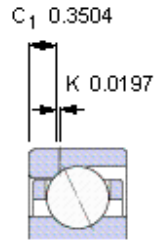
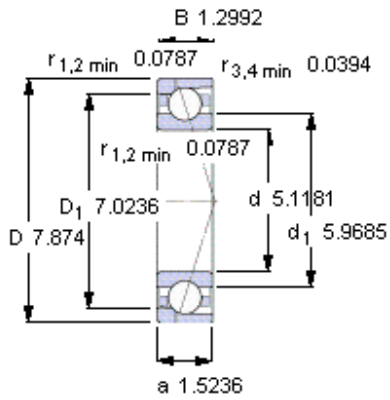

Ball diameter 22,225

Number of balls 21

未安装时的预载荷 [N]

背对背配置，面对面配置

预载荷等级

A	B	C	D
560	1120	2240	4480

Static axial stiffness [N/μm]

(guideline value)

预载荷等级

A	B	C	D
161	219	307	444

Reference grease quantity [cm³]

G_{ref} 42

计算系数

for equivalent bearing load

f₀ 15,6

for preload in mounted bearing sets

f 1,15

f₁ 1

f_{2A} 1

f_{2B} 1,02

f_{2C} 1,05

f_{2D} 1,09

f_{HC} 1,02