

### KOYO 682参数

主要尺寸	SD	2.0	mm	内径
	D	5	mm	外径
	B	1.5	mm	宽度
	R	0.10	mm	(最小)
型号	ORDER	682		型号
基本额定载荷	C	170	N	动载荷
	C0	50	N	静载荷
极限转速	NG	98000	1/min	脂润滑
	NO	110000	1/min	油润滑

### KOYO 682图片

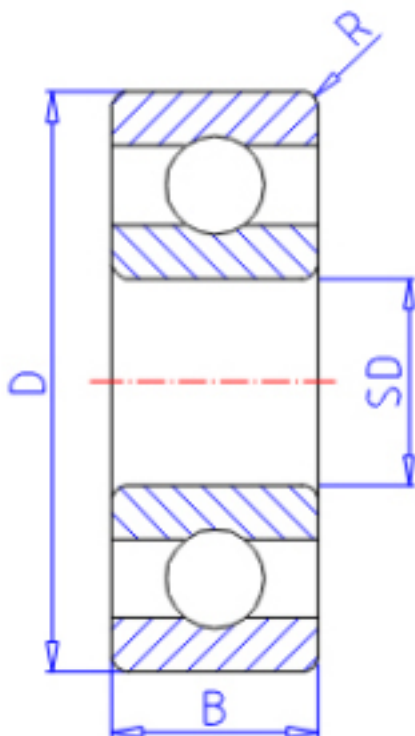

参考资料:<http://www.sozhou.com/p/94883992.html>

