

SKF 71944 CD/HCP4AL 参数

| | | | | |
|--------|---------|-----------------|-------|-----|
| 主要尺寸 | d | 220 | mm | - |
| | D | 300 | mm | - |
| | B | 38 | mm | - |
| 基本额定载荷 | C | 221000 | N | 动载荷 |
| | C_0 | 300000 | N | 静载荷 |
| 疲劳载荷极限 | P_u | 7800 | N | - |
| 可达转速 | Grease | 5300 | r/min | - |
| | Oil-air | 7500 | r/min | - |
| 重量 | 重量 | 5550 | g | - |
| 型号 | 型号 | 71944 CD/HCP4AL | - | - |

SKF 71944 CD/HCP4AL 图片

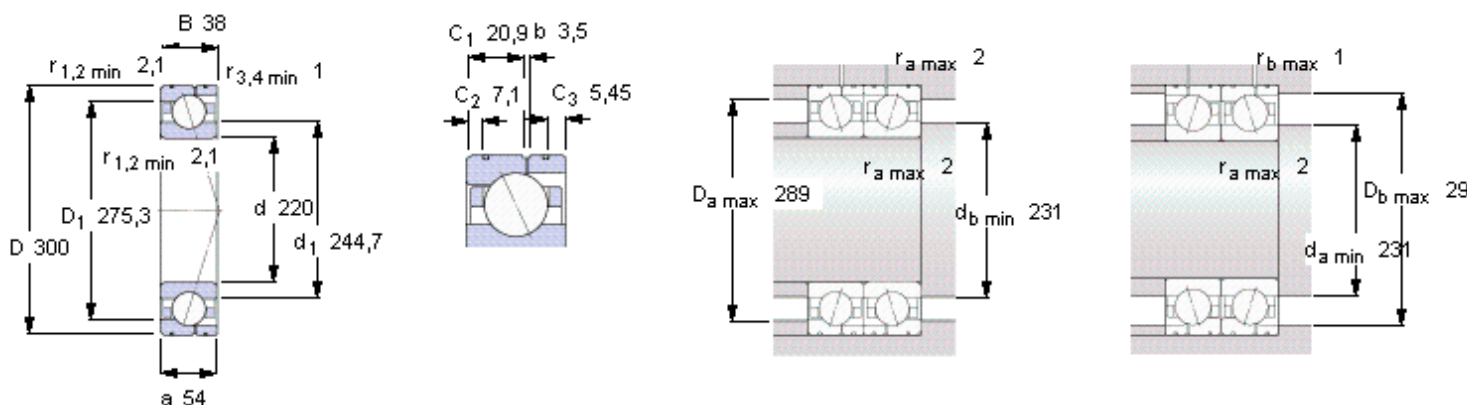

Ball diameter 25,4

Number of balls 29

未安装时的预载荷 [N]

背对背配置，面对面配置

预载荷等级

| A | B | C | D |
|-----|------|------|------|
| 850 | 1700 | 3400 | 6800 |

Static axial stiffness [N/μm]

(guideline value)

预载荷等级

| A | B | C | D |
|-----|-----|-----|-----|
| 248 | 340 | 481 | 705 |

Reference grease quantity [cm³]

G_{ref} 84

计算系数

for equivalent bearing load

f_0 16,5

for preload in mounted bearing sets

f 1,28

f_1 1

f_{2A} 1

f_{2B} 1,07

f_{2C} 1,12

f_{2D} 1,18

f_{HC} 1,04

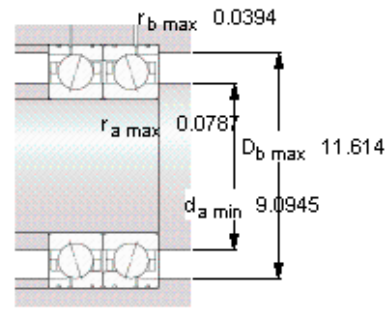
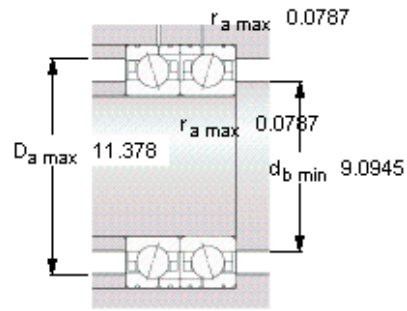
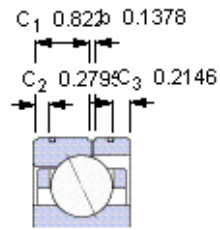
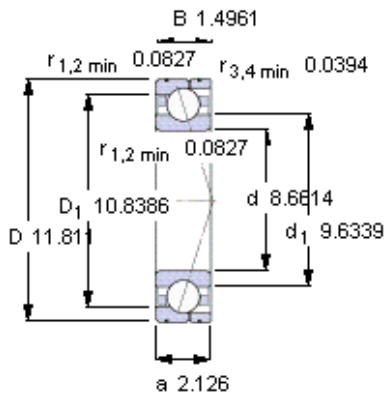

Ball diameter 25,4

Number of balls 29

未安装时的预载荷 [N]

背对背配置，面对面配置

预载荷等级

| A | B | C | D |
|-----|------|------|------|
| 850 | 1700 | 3400 | 6800 |

Static axial stiffness [N/μm]

(guideline value)

预载荷等级

| A | B | C | D |
|-----|-----|-----|-----|
| 248 | 340 | 481 | 705 |

Reference grease quantity [cm³]

G_{ref} 84

计算系数

for equivalent bearing load

f₀ 16,5

for preload in mounted bearing sets

f 1,28

f₁ 1

f_{2A} 1

f_{2B} 1,07

f_{2C} 1,12

f_{2D} 1,18

f_{HC} 1,04