

INA PWTR2052-2RS参数

尺寸	d	20	mm	-
	D	52	mm	-
	B	25	mm	-
	C	24	mm	-
	d ₂	27	mm	-
	r _{1 min}	0.5	mm	-
	r _{min}	1	mm	-
重量	m	321	g	质量
基本额定载荷	C _{r w}	27000	N	滚轮的有效额定动载荷 (径向)
	C _{0r w}	35000	N	滚轮的有效额定静载荷 (径向)
	F _{r per}	31000	N	许可动态径向载荷
	F _{0r per}	35000	N	许可静态径向载荷
疲劳极限载荷	C _{ur w}	4250	N	疲劳极限载荷
极限转速	n _{D G}	3800	r/min	转速 (脂润滑下连续运转)

INA PWTR2052-2RS图片

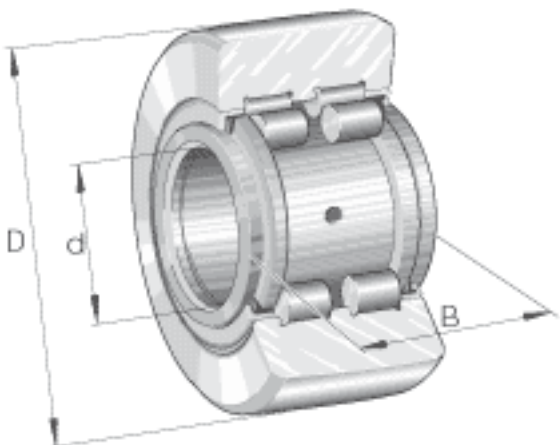

参考资料:<http://www.sozhou.com/p/7622c7c4.html>

