

TIMKEN 150RU03参数

轴承型号	Part Number	150RU03		-
	Subtype	NU		-
尺寸	d	150	mm	内径
	D	319.999	mm	外径
	B	65.0011	mm	宽度
额定载荷	C1	800680	N	一百万转动态径向载荷
	C0	796232	N	静态额定载荷
几何结构系数	Cg	0.1606		几何系数
极限转速	oil	2400		润滑油
	grease	1900		润滑脂
尺寸	R	3.048	mm	最大轴肩倒角半径
	da	181.864	mm	轴肩直径
	r	3.048	mm	最大轴承座挡肩圆角半径
	Da	288.036	mm	轴承座挡肩直径
重量	Assembly Weight	27782.53	g	-

TIMKEN 150RU03图片

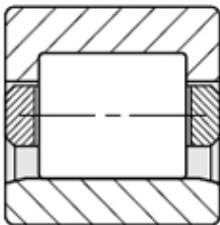
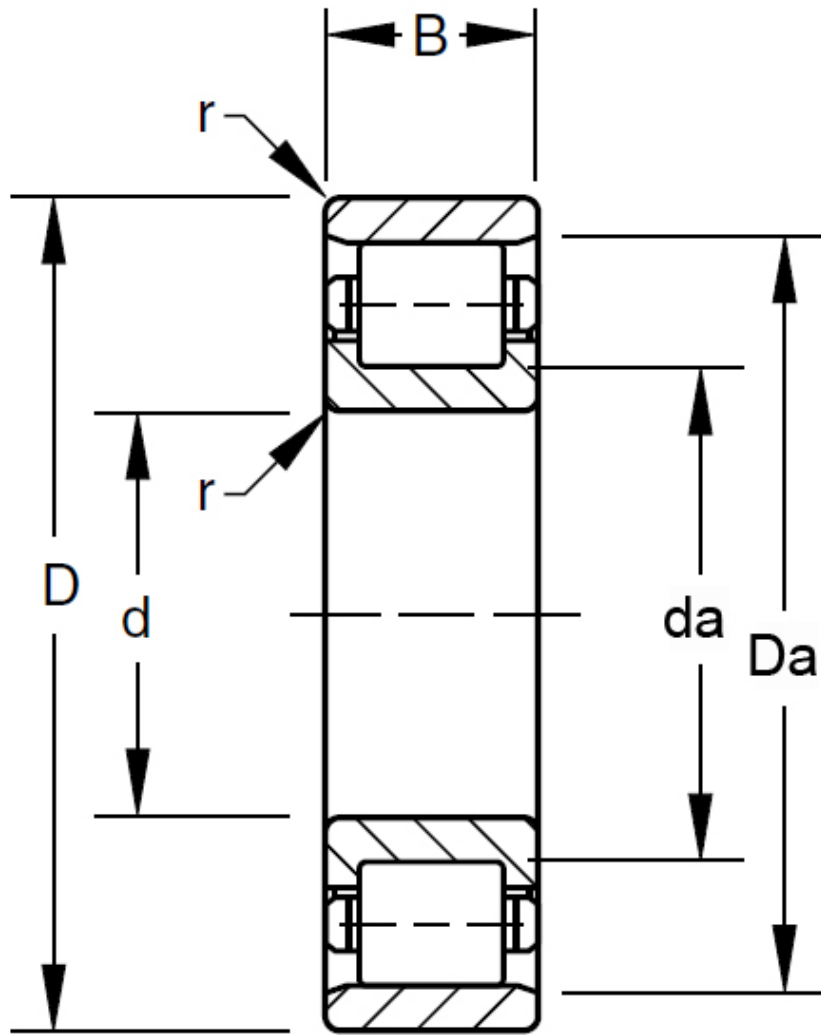

RU
RIU

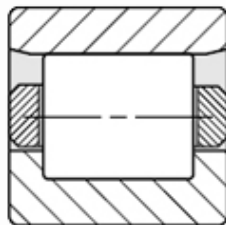

RN
RIN

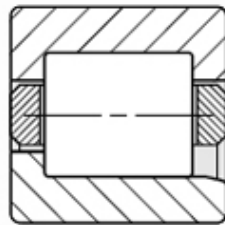

RJ
RIJ

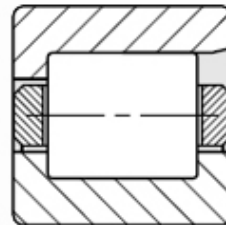

RF
RIF

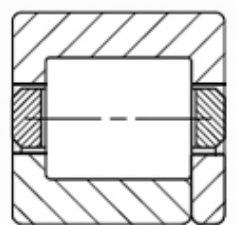

RT
RIT

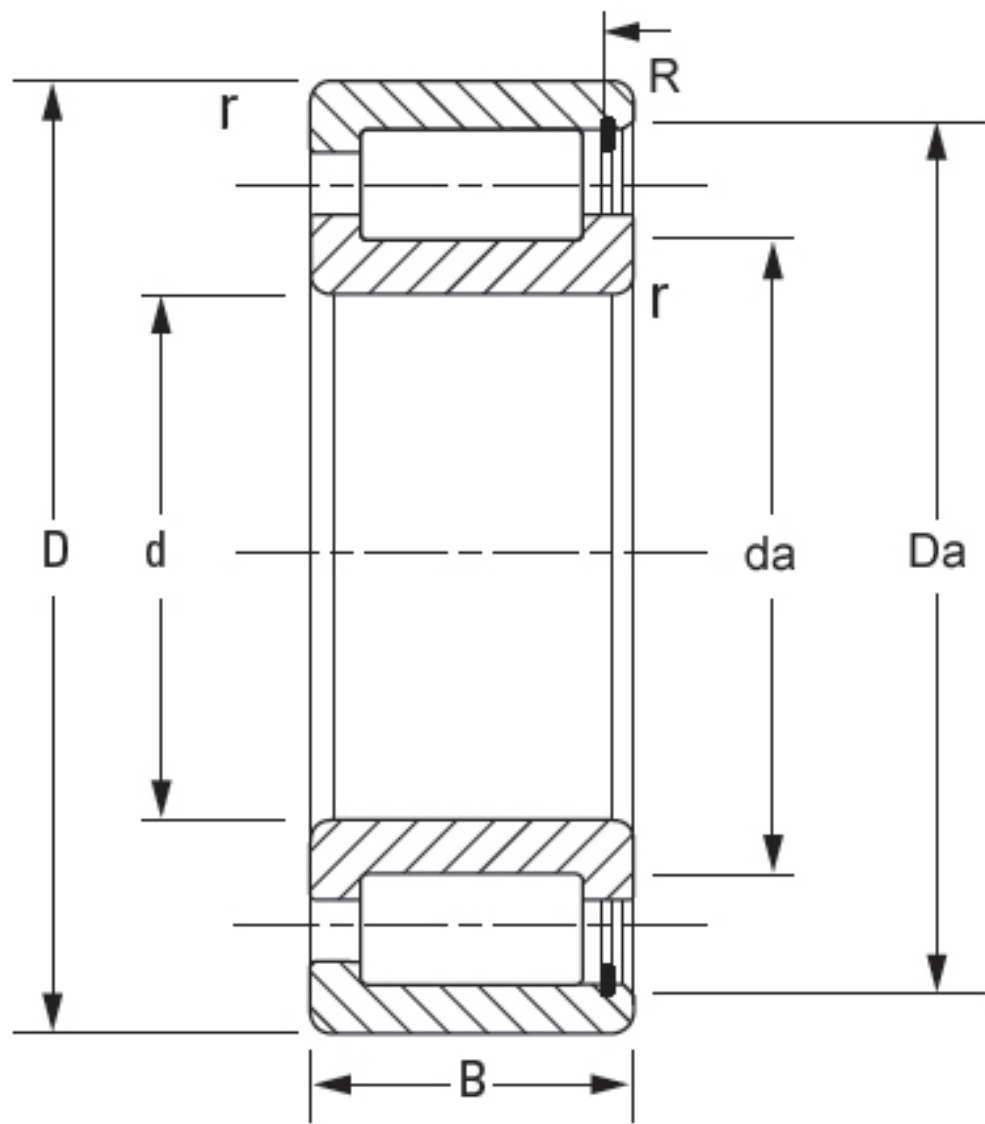

NCF