

SKF 51406参数

主要尺寸	d	30	mm	-
	D	70	mm	-
	H	28	mm	-
基本额定载荷	C	72800	N	动载荷
	C_0	137000	N	静载荷
疲劳载荷极限	P_u	5100	N	-
最小载荷系数	A	0.097	-	-
额定转速	额定转度	3000	r/min	-
	极限转速	4300	r/min	-
重量	重量	520	g	-
型号	型号	51406	-	-

SKF 51406图片

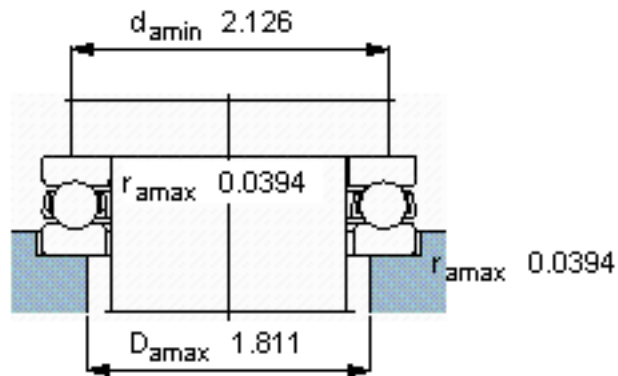
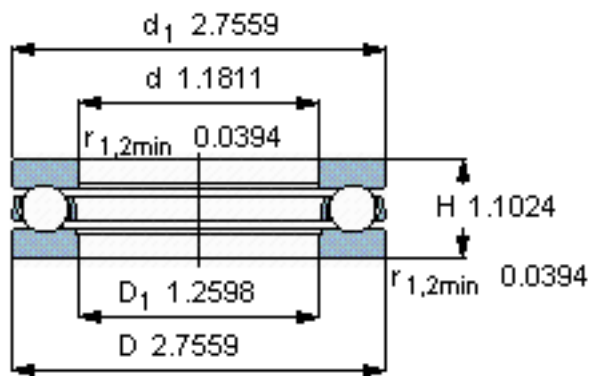
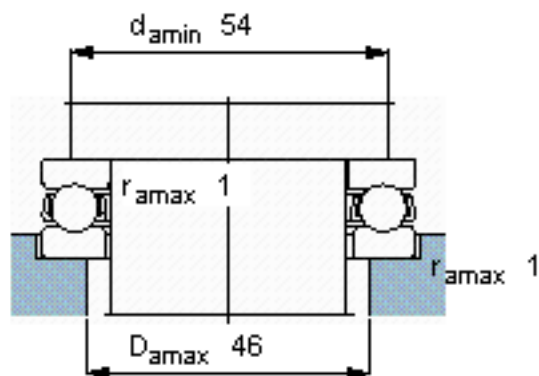
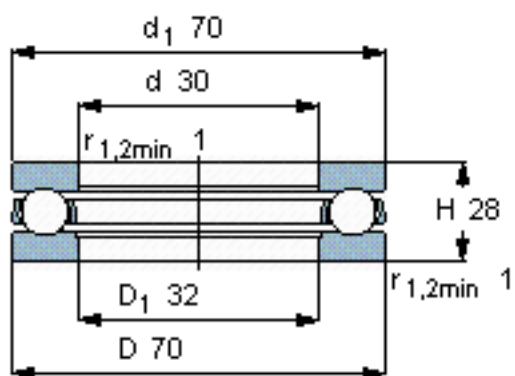

参考资料:<http://www.sozhou.com/p/6459b491.html>