

SKF S71909 CB/HCP4A参数

主要尺寸	d	45	mm	-
	D	68	mm	-
	B	12	mm	-
基本额定载荷	C	7410	N	动载荷
	C_0	5700	N	静载荷
疲劳载荷极限	P_u	245	N	-
可达转速	Grease	32000	r/min	-
	Oil-air	-	r/min	-
重量	重量	130	g	-
型号	型号	S71909 CB/HCP4A	-	-

SKF S71909 CB/HCP4A图片

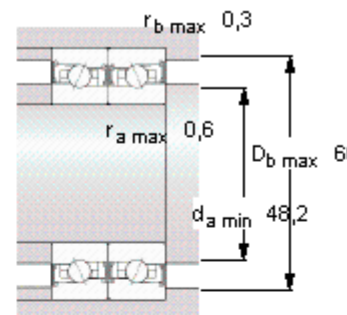
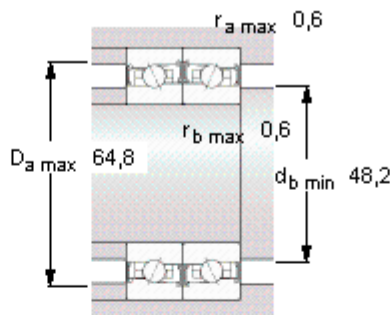
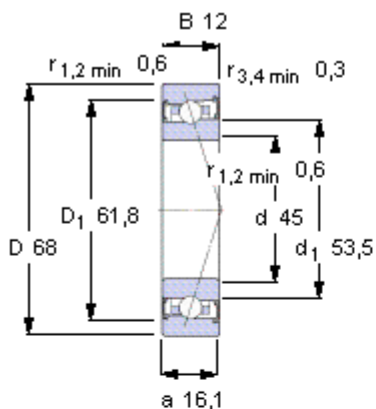

Ball diameter 4,762

Number of balls 27

未安装时的预载荷 [N]

背对背配置，面对面配置

预载荷等级

A	B	C	D
24	48	145	-

Static axial stiffness [N/μm]

(guideline value)

预载荷等级

A	B	C	D
32	41	66	-

Reference grease quantity [cm³]

G_{ref} -

计算系数

for equivalent bearing load

f_0 9,7

for preload in mounted bearing sets

f 1,08

f_1 1

f_{2A} 1

f_{2B} 1,03

f_{2C} 1,08

f_{2D} -

f_{HC} 1,01

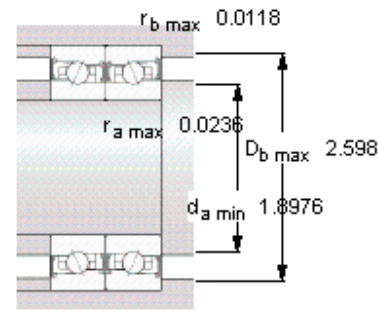
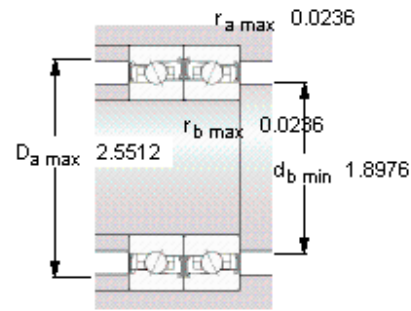
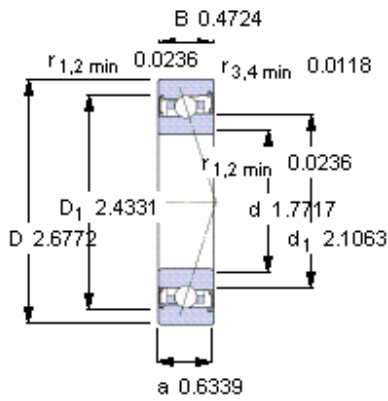

Ball diameter 4,762

Number of balls 27

未安装时的预载荷 [N]

背对背配置，面对面配置

预载荷等级

A	B	C	D
24	48	145	-

Static axial stiffness [N/μm]

(guideline value)

预载荷等级

A	B	C	D
32	41	66	-

Reference grease quantity [cm³]

G_{ref} -

计算系数

for equivalent bearing load

f₀ 9,7

for preload in mounted bearing sets

f 1,08

f₁ 1

f_{2A} 1

f_{2B} 1,03

f_{2C} 1,08

f_{2D} -

f_{HC} 1,01