

SKF 7032 CD/HCP4A参数

主要尺寸	d	160	mm	-
	D	240	mm	-
	B	38	mm	-
基本额定载荷	C	195000	N	动载荷
	C_0	216000	N	静载荷
疲劳载荷极限	P_u	6550	N	-
可达转速	Grease	6700	r/min	-
	Oil-air	11000	r/min	-
重量	重量	4250	g	-
型号	型号	7032 CD/HCP4A	-	-

SKF 7032 CD/HCP4A图片

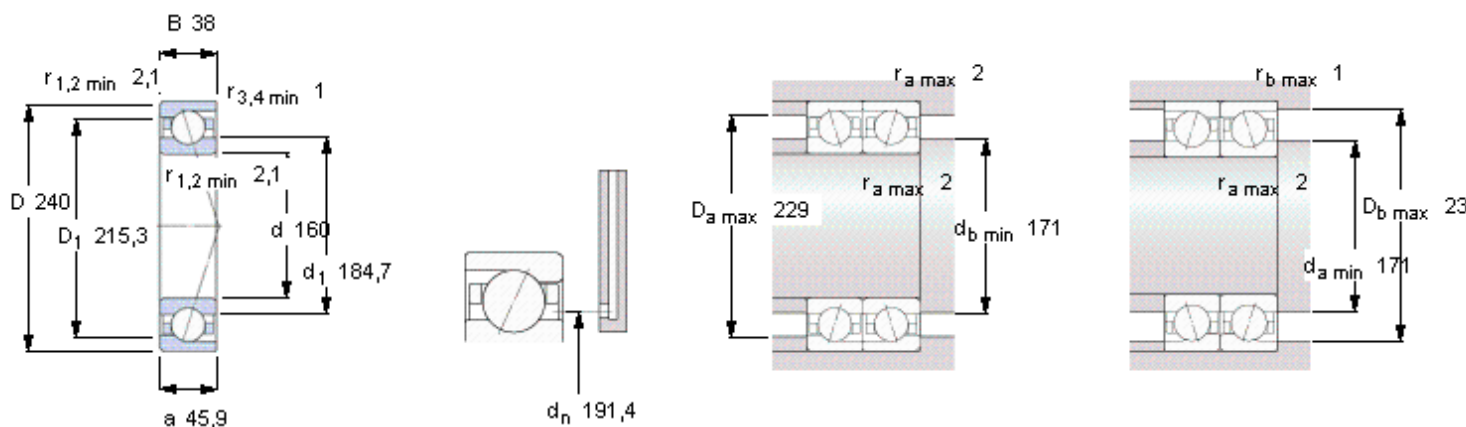

Ball diameter 25,4

Number of balls 22

未安装时的预载荷 [N]

背对背配置，面对面配置

预载荷等级

A	B	C	D
730	1460	2920	5840

Static axial stiffness [N/μm]

(guideline value)

预载荷等级

A	B	C	D
190	259	363	524

Reference grease quantity [cm³]

G_{ref} 66

计算系数

for equivalent bearing load

f_0 15,8

for preload in mounted bearing sets

f 1,16

f_1 1

f_{2A} 1

f_{2B} 1,02

f_{2C} 1,05

f_{2D} 1,09

f_{HC} 1,02

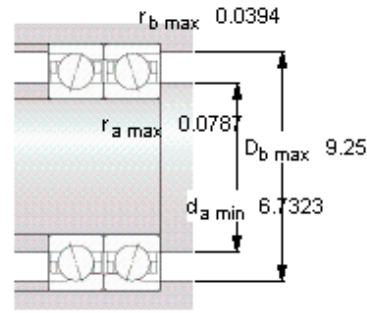
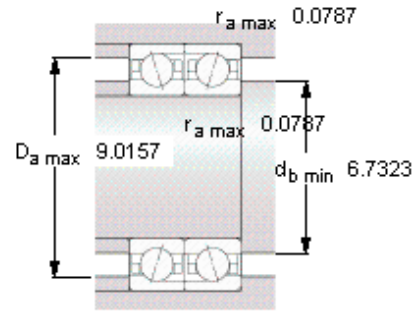
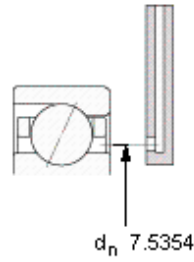
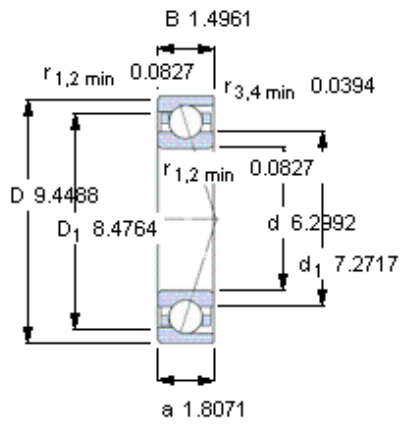

Ball diameter 25,4

Number of balls 22

未安装时的预载荷 [N]

背对背配置，面对面配置

预载荷等级

A	B	C	D
730	1460	2920	5840

Static axial stiffness [N/μm]

(guideline value)

预载荷等级

A	B	C	D
190	259	363	524

Reference grease quantity [cm³]

G_{ref} 66

计算系数

for equivalent bearing load

f₀ 15,8

for preload in mounted bearing sets

f 1,16

f₁ 1

f_{2A} 1

f_{2B} 1,02

f_{2C} 1,05

f_{2D} 1,09

f_{HC} 1,02