

SKF 708 CD/HCP4A参数

主要尺寸	d	8	mm	-
	D	22	mm	-
	B	7	mm	-
基本额定载荷	C	3250	N	动载荷
	C_0	1370	N	静载荷
疲劳载荷极限	P_u	57	N	-
可达转速	Grease	110000	r/min	-
	Oil-air	160000	r/min	-
重量	重量	11	g	-
型号	型号	708 CD/HCP4A	-	-

SKF 708 CD/HCP4A图片

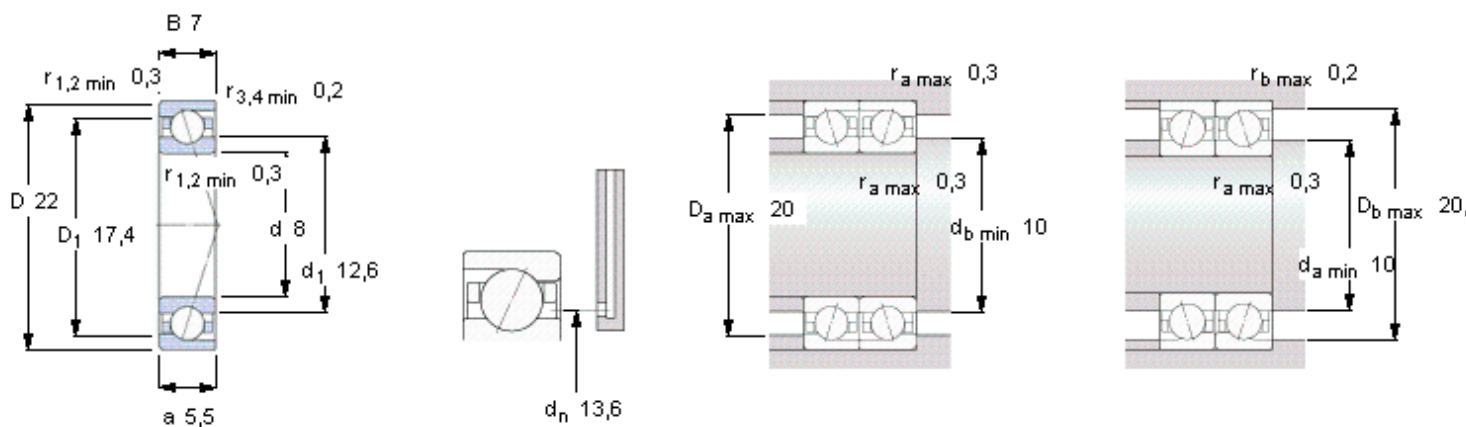

Ball diameter 3,969

Number of balls 9

未安装时的预载荷 [N]

背对背配置，面对面配置

预载荷等级

A	B	C	D
10	20	40	80

Static axial stiffness [N/μm]

(guideline value)

预载荷等级

A	B	C	D
12	16	21	30

Reference grease quantity [cm³]

G_{ref} 0,15

计算系数

for equivalent bearing load

f_0 8,4

for preload in mounted bearing sets

f 1,02

f_1 1

f_{2A} 1

f_{2B} 1,02

f_{2C} 1,05

f_{2D} 1,09

f_{HC} 1,02

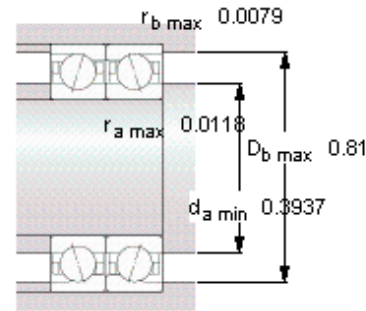
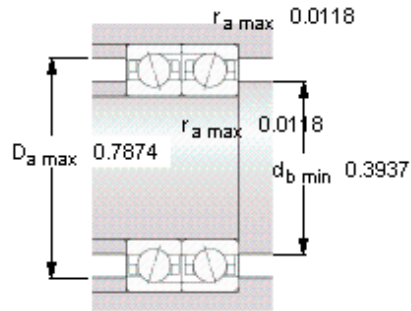
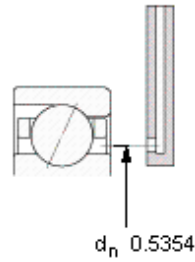
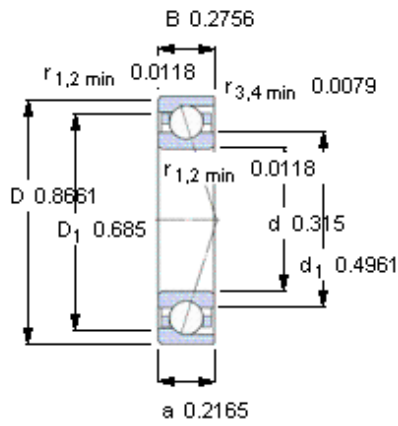

Ball diameter 3,969

Number of balls 9

未安装时的预载荷 [N]

背对背配置，面对面配置

预载荷等级

A	B	C	D
10	20	40	80

Static axial stiffness [N/μm]

(guideline value)

预载荷等级

A	B	C	D
12	16	21	30

Reference grease quantity [cm³]

G_{ref} 0,15

计算系数

for equivalent bearing load

f₀ 8,4

for preload in mounted bearing sets

f 1,02

f₁ 1

f_{2A} 1

f_{2B} 1,02

f_{2C} 1,05

f_{2D} 1,09

f_{HC} 1,02